

**RECEPTACLE, PANEL MOUNTED**

<b>Part No.</b>	ME 530R7W
<b>Description:</b>	30 Amp 3 Y 277/480Vac 4 Pole, 5 Wire Receptacle
<b>Construction:</b>	Watertight IEC IP 67
<b>Approvals:</b>	UL Listed Standards 1682; 1686 CSA Certification to Spec. C22.2 No. 182.1 IEC 60309-1; IEC 60309-2

**IEC COLOR CODE:** Red

**GROUND SOCKET:** 7 Hour Position Mates with Male in 5 Hour Position.

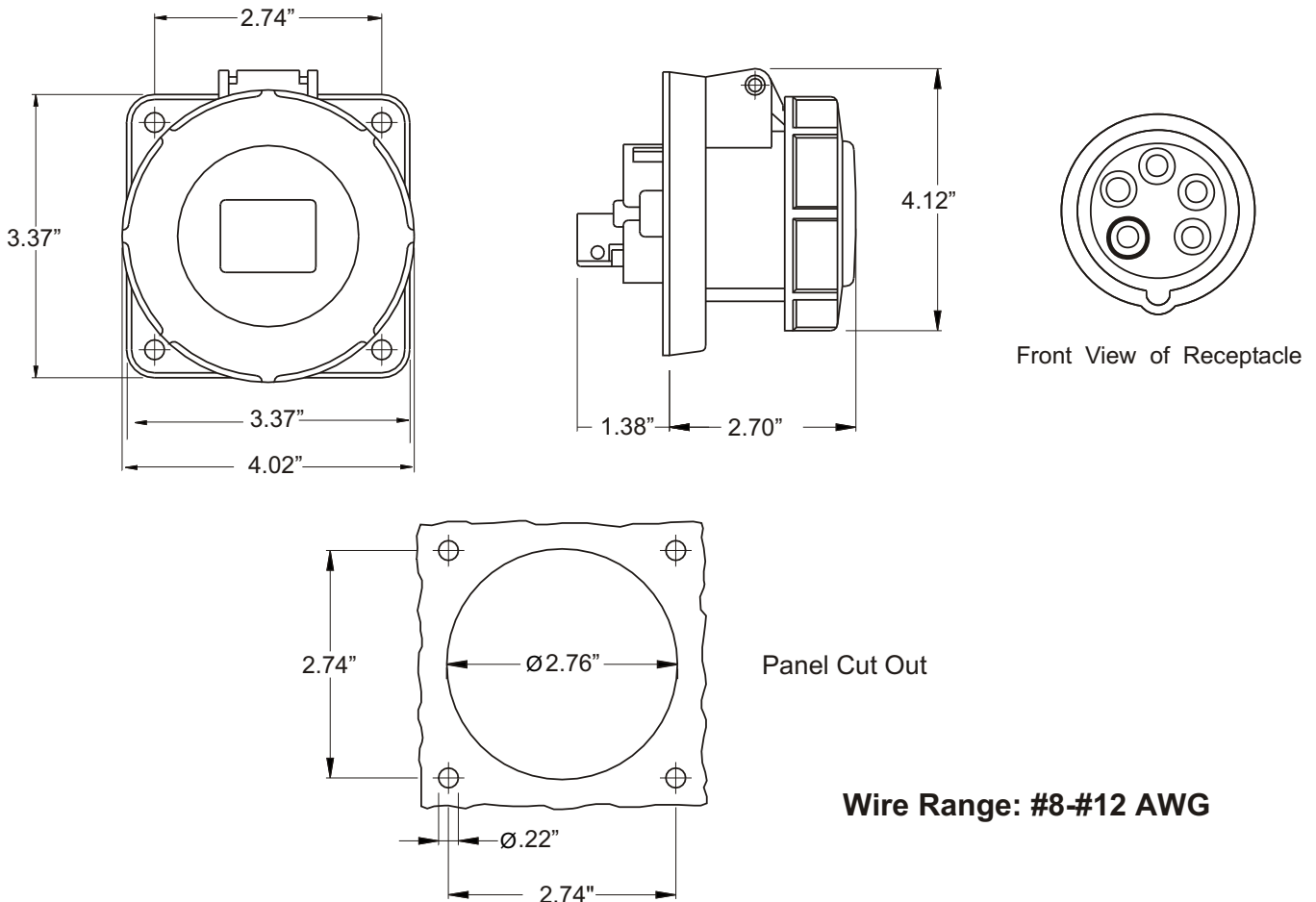

Drawing Not to Scale